

INDUSTRIAL PRESSURE TRANSMITTER

Swiss based Trafag is a leading international supplier of high quality sensors and monitoring instruments for measurement of pressure and temperature. The economic pressure transmitter ECT 8473 is based on the tried and true ECT line of transmitters with the wide media temperature range from -25 to 125°C. The enhanced accuracy and the low pressure ranges down to 100 mbar in combination with a comprehensive set of features, materials and options makes the ECT 8473 pressure transmitter an ideal and versatile solution suitable for a wide variety of applications.



Applications

- Machine tools
- Hydraulics
- Water treatment

Features

- Measuring ranges from 100 mbar
- Excellent media compatibility
- Relative or absolute pressure measurement
- Titanium version optional
- Frontal membrane optional

Technical Data			
Measuring principle	Thick-film-on-ceramic	Accuracy @ 25°C typ.	± 0.3 % FS typ. (± 0.5 % FS typ., ± 1 % FS typ.)
Measuring range	0 ... 0.1 to 0 ... 40 bar 0 ... 1.5 to 0 ... 500 psi	Media temperature	-25°C ... +125°C
Output signal	4 ... 20 mA, 0 ... 5 VDC, 1 ... 6 VDC, 0 ... 10 VDC, 0.5 ... 4.5 VDC ratiom.	Ambient temperature	-25°C ... +125°C Cable PVC 22: -5°C ... +60°C Cable PUR 24: -20°C ... +70°C Cable Raychem 08: -20°C ... +100°C
NLH @ 25°C (BSL) typ.	± 0.2 FS typ. (± 0.3 FS typ.)		

11/2019

Data sheet H72326ac

Subject to change

Ordering information/type code

				8473 .	XX	XX	XX	XX	XX	
Measuring range ¹⁾	Pressure measurement range [bar]	Over pressure [bar]	Burst pressure [bar]							
	0 ... 0.1	1.2	2	66						
	0 ... 0.16	1.2	2	67						
	0 ... 0.2	1.2	2	68						
	0 ... 0.4	1.2	2	69						
	0 ... 0.6	1.2	2	70						
	0 ... 1.0	2	3	71						
	0 ... 1.6	3.2	4.8	73						
	0 ... 2.5	5	7.5	75						
	0 ... 4	8	12	76						
	0 ... 6	12	15	77						
	0 ... 10	20	25	78						
	0 ... 16	32	40	79						
	0 ... 25	50	75	80						
	0 ... 40	80	100	81						
	Option 5P:	Fivefold overpressure								
	0 ... 2.5	12.5	18	55						
	0 ... 4	20	30	56						
	0 ... 6	30	48	57						
	0 ... 10	50	75	58						
0 ... 16	80	120	59							
Sensor	Relative pressure, Material pressure connection and housing: 1.4305 (AISI303)			54	Absolute pressure, Material pressure connection and housing: 1.4305 (AISI303) ^{2) 3)}				84	
	Relative pressure, Material pressure connection and housing: 1.4404/1.4435 (AISI316L) ²⁾			56	Absolute pressure, Material pressure connection and housing: 1.4404/1.4435 (AISI316L) ^{2) 3)}				86	
	Relative pressure, Material pressure connection and housing: 1.4462 (AISI318LN) ²⁾			50	Absolute pressure, Material pressure connection and housing: 1.4462 (AISI318LN) ^{2) 3)}				80	
	Relative pressure, titanium grade 5 ²⁾			51	Absolute pressure, titanium grade 5 ^{2) 3)}				81	
Pressure connection	G1/4" female ²⁾								10	
	G1/4" male								17	
	G1/2" male DIN3852-A ²⁾								21	
	G1/2" male DIN3852-E ²⁾								41	
	G1/2" male DIN3852-E, with inner cone ^{2) 12)}								59	
	1/4" NPT male, ANSI B1.20.1 ²⁾								30	
	1/8" NPT male, ANSI B1.20.1 ^{2) 10)}								43	
	7/16"-20UNF male, SAE4 (J1926) ²⁾								42	
	7/16"-20UNF male, DIN3866 ³⁾								18	
	7/16"-20UNF female, SAE J512 with valve opener ³⁾								24	
	R1/4" male, DIN3858 ²⁾								19	
	G3/4" frontal membrane ^{2) 4)}								52	
Electrical connection	Male electrical connector EN 175301-803-A (DIN43650-A), Mat. PA								05	
	Male electrical connector M12x1, 5-pole, Mat. PA (Old shape), Mat. PBT (New shape)								35	
	Male electrical connector, industrial standard (contact distance 9.4 mm), Mat. PBT								01	
	Male electrical connector Packard Metri Pack, Mat. PBT								51	
	Cable PUR (Screwed cable gland PA 6-3), -20°C ... +70°C ^{5) 6)}								24	
	Cable PVC (Screwed cable gland PA 6-3), -5°C ... +60°C ^{5) 6) 9)}								22	
	Cable Raychem (Screwed cable gland PA 6-3), -20°C ... +100°C ^{3) 6) 9)}								08	

Output signal	Signal output	Load resistance	I (supply)	U (supply)		
	4 ... 20 mA	(U _{supply} -9 V) / 20 mA		9 ... 30 VDC	19	
	0 ... 5 VDC	≥ 2.5 kΩ	≤ 10 mA	10 ... 30 VDC	14	
	1 ... 6 VDC	≥ 5.0 kΩ	≤ 10 mA	10 ... 30 VDC	16	
	0 ... 10 VDC	≥ 5.0 kΩ	≤ 10 mA	15 ... 30 VDC	17	
	0.5 ... 4.5 VDC	≥ 5.0 kΩ	≤ 10 mA	5 VDC ± 0.25 VDC ratiom.	23	
Accessories	Seal FKM (-20°C ... +125°C)				61	
	Seal CR ≤ 100 bar (-25°C ... +100°C) ⁷⁾				62	
	Seal EPDM (-25°C ... +125°C)				63	
	Pressure peak damping element ø 1.0 mm, material 1.4305 ⁸⁾				40	
	Pressure peak damping element ø 0.4 mm, material 1.4305 (sensors 54, 84) resp. 1.4404 (sensors 50, 51, 56, 80, 81, 86) ⁸⁾				44	
	Female electrical plug EN 175301-803-A (DIN43650-A)/NBR, -40°C ... +90°C, for cable diameter 4 ... 9 mm, flammability standard UL94-V0					46
	Female electrical plug EN 175301-803-A (DIN43650-A)/Silicone, -40°C ... +125°C, for cable diameter 4 ... 9 mm, flammability standard UL94-V0					56
	Female electrical plug EN 175301-803-A (DIN43650-A)/NBR, -40°C ... +90°C, for cable diameter 4 ... 9.5 mm, flammability standard UL94-V2					58
	Female electrical plug M12x1, 5-pole					33
	Female electrical plug industrial standard					34
	Special electrical connection: Pin 1 +, Pin 2 - (only for output signal 4 ... 20 mA and male electrical connector EN175301-803-A / DIN43650-A)					92
	Special electrical connection: Pin 1 Out, Pin 2 -, Pin 3 + (only for output 14, 16, 17, 23 and male electrical connector EN175301-803-A / DIN43650-A)					98
	Special electrical connection: Pin 1 +, Pin 2 -, Pin 3 Out (only for output signals 14, 16, 17, 23 and male electrical connector EN 175301-803-A / DIN 43650-A)					97
	Special electrical connection: Pin 1 +, Pin 3 - (only for output 4 ... 20 mA and male electrical connector Packard Metri Pack 3-poles)					E4
	Special electrical connection: Pin 1 +, Pin 2 Out, Pin 3 - (only for output signals 14, 16, 17, 23 and male electrical connector Packard Metri Pack 3-poles)					99
	Special electrical connection: Pin 1 +, Pin 3 -, Pin 5 Ground (only for output signal 4 ... 20 mA and male electrical connector 35, M12x1, 5-pole)					94
	Special electrical connection: Pin 1 Out, Pin 2 -, Pin 3 +, Pin 4 Ground (only for output signals 14, 16, 17, 23 and male electrical connector 01, industrial standard)					E3
	Cable length 1.5 m					1M
	Cable length 3.0 m					3M
	Cable length 5.0 m					5M
	Housing nut for electrical connection EN175301-803-A (DIN43650-A) secured with Loctite (max. 85°C)					L9
	Multiple packaging ¹¹⁾					VM

¹⁾ Extended overpressure as well as customized pressure ranges upon request

²⁾ Upon request

³⁾ Only for ranges: ≥ 400 mbar or 5 psi

⁴⁾ Not for sensors 54 and 84, only for pressure ranges ≤ 25 bar or 400 psi

⁵⁾ Cable length see accessories (max. length 50 m, in 5-meter sections)

⁶⁾ Protection IP68: Immersion depth max. 3 m, Media +10°C ... +35°C

⁷⁾ Only for pressure connections 10, 30, 43, 42, 18, 24, 19

⁸⁾ Not for pressure connections 10, 52

⁹⁾ Pressure ranges > 16 bar (Pressure ranges ≤ 16 bar upon request)

¹⁰⁾ Only for sensors 56 and 86 and electrical connections 01, 35, 51 (others on request)

¹¹⁾ The order quantity must be a multiple of 50, only for electrical connections 05 and 35

¹²⁾ Only for sensors 50 and 80



Vacuum measuring ranges: Measuring ranges below 0 bar (e.g. -1 bar ... 0 bar) are available as special pressure ranges.

Reversed calibration: A reversed calibration is also possible for measuring ranges below 0 bar, with the signals 4 ... 20 mA (code 19), 1 ... 6 VDC (code 16) and 0 ... 10 VDC (code 17). The signal zero point is at 0 bar, the signal end point can be individually chosen between -1 bar and -0.1 bar.

Additional configurations on request.

Standard products (extra short lead time)

Product No.	Type Code	Pressure range [bar]	Over pressure max. [bar]	Pressure connection	Signal output	Accuracy @ 25°C typ. [%]
ECT0.1A	8473 66 5417 05 0000 0000 19 58 61	0 ... 0.1	1.2	G1/4" male	4 ... 20 mA	1.0
ECT0.16A	8473 67 5417 05 0000 0000 19 58 61	0 ... 0.16	1.2	G1/4" male	4 ... 20 mA	1.0
ECT0.2A	8473 68 5417 05 0000 0000 19 58 61	0 ... 0.2	1.2	G1/4" male	4 ... 20 mA	0.5
ECT0.4A	8473 69 5417 05 0000 0000 19 58 61	0 ... 0.4	1.2	G1/4" male	4 ... 20 mA	0.5
ECT0.6A	8473 70 5417 05 0000 0000 19 58 61	0 ... 0.6	1.2	G1/4" male	4 ... 20 mA	0.3
ECT0.1V	8473 66 5417 05 0000 0000 17 58 61	0 ... 0.1	1.2	G1/4" male	0 ... 10 VDC	1.0
ECT0.16V	8473 67 5417 05 0000 0000 17 58 61	0 ... 0.16	1.2	G1/4" male	0 ... 10 VDC	1.0
ECT0.2V	8473 68 5417 05 0000 0000 17 58 61	0 ... 0.2	1.2	G1/4" male	0 ... 10 VDC	0.5
ECT0.4V	8473 69 5417 05 0000 0000 17 58 61	0 ... 0.4	1.2	G1/4" male	0 ... 10 VDC	0.5
ECT0.6V	8473 70 5417 05 0000 0000 17 58 61	0 ... 0.6	1.2	G1/4" male	0 ... 10 VDC	0.3
ECTF0.1A	8473 66 5652 05 0000 0000 19 58 61	0 ... 0.1	1.2	G3/4" frontal membrane	4 ... 20 mA	1.0
ECTF0.16A	8473 67 5652 05 0000 0000 19 58 61	0 ... 0.16	1.2	G3/4" frontal membrane	4 ... 20 mA	1.0
ECTF0.2A	8473 68 5652 05 0000 0000 19 58 61	0 ... 0.2	1.2	G3/4" frontal membrane	4 ... 20 mA	0.5
ECTF0.4A	8473 69 5652 05 0000 0000 19 58 61	0 ... 0.4	1.2	G3/4" frontal membrane	4 ... 20 mA	0.5
ECTF0.6A	8473 70 5652 05 0000 0000 19 58 61	0 ... 0.6	1.2	G3/4" frontal membrane	4 ... 20 mA	0.3
ECTF1.0A	8473 71 5652 05 0000 0000 19 58 61	0 ... 1	2	G3/4" frontal membrane	4 ... 20 mA	0.3
ECTF1.6A	8473 73 5652 05 0000 0000 19 58 61	0 ... 1.6	3.2	G3/4" frontal membrane	4 ... 20 mA	0.3
ECTF2.5A	8473 75 5652 05 0000 0000 19 58 61	0 ... 2.5	5	G3/4" frontal membrane	4 ... 20 mA	0.3
ECTF4.0A	8473 76 5652 05 0000 0000 19 58 61	0 ... 4	8	G3/4" frontal membrane	4 ... 20 mA	0.3
ECTF6.0A	8473 77 5652 05 0000 0000 19 58 61	0 ... 6	12	G3/4" frontal membrane	4 ... 20 mA	0.3
ECTF10.0A	8473 78 5652 05 0000 0000 19 58 61	0 ... 10	20	G3/4" frontal membrane	4 ... 20 mA	0.3

Specifications		
Electrical Data	Output / supply voltage	4 ... 20 mA: 24 (9 ... 30) VDC 0 ... 5 VDC: 24 (10 ... 30) VDC 1 ... 6 VDC: 24 (10 ... 30) VDC 0 ... 10 VDC: 24 (15 ... 30) VDC 0.5 ... 4.5 VDC: 5 VDC ratiom.
	Rise time	Typ. 1 ms / 10 ... 90 % nominal pressure
	Switch-on-delay	Max. 1.5 s
	Inverse-polarity protection, short-circuit strength @ 25°C during 5 min.	4...20 mA: to $U_s = 30$ VDC 0...10 VDC, 0...5 VDC, 1...6 VDC: to $U_s = 30$ VDC 0.5...4.5 VDC ratiometric: to $U_s = 5.25$ VDC
Environmental conditions	Media temperature	-25°C ... +125°C
	Ambient temperature	-25°C ... +125°C Cable PVC 22: -5°C ... +60°C Cable PUR 24: -20°C ... +70°C Cable Raychem 08: -20°C ... +100°C
	Protection ¹⁾	IP65, IP67, IP68
	Humidity	Max. 95 % relative
	Vibration	4 g (10...2000 Hz)
	Shock	50 g / 8 ms
EMC Protection	Emission	EN/IEC 61000-6-3
	Immunity	EN/IEC 61000-6-2
Mechanical Data	Sensor (wetted parts)	Ceramic, Al ₂ O ₃ (96 %)
	Pressure connection (wetted parts)	54/84: 1.4305 (AISI303) 56/86: 1.4404/1.4435 (AISI316L) 50/80: 1.4462 (AISI318LN) 51/81: Titanium Grade 5
	Housing	54/84: 1.4305 (AISI303) 56/86: 1.4404/1.4435 (AISI316L) 50/80: 1.4462 (AISI318LN) 51/81: Titanium Grade 5
	Sealing	FKM 70 Sh, CR, EPDM
	Male electrical plug	See ordering information
	Weight	~ 110 g
	Mounting torque	15 ... 20 Nm

¹⁾ See electrical connection

Accuracy				
Pressure measuring range	[bar]	> 0 ... 0.4	0 ... 0.2	0 ... 0.1
	[psi]	> 0 ... 5	0 ... 0.4	0 ... 0.16
			0 ... 2.5	0 ... 1.5
			0 ... 5	0 ... 2
TEB @ -25 ... +85°C	[% FS typ.]	± 1.0	± 2.0	± 3.0
Accuracy @ +25°C	[% FS typ.]	± 0.3	± 0.5	± 1.0
NLH @ +25°C (BSL)	[% FS typ.]	± 0.2	± 0.3	± 0.3
TC zero point and span	[% FS/K typ.]	± 0.02	± 0.02	± 0.02
Long term stability 1 year @ +25°C	[% FS typ.]	± 0.2	± 0.2	± 0.2

Measuring accuracy 1.0 %

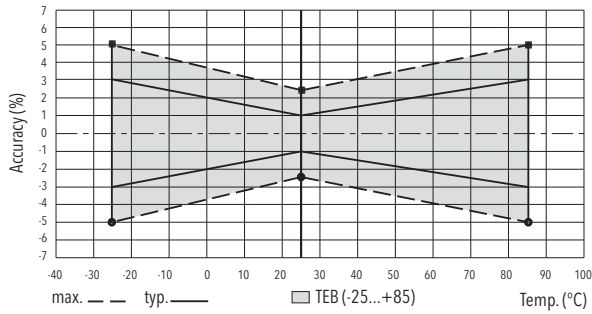

Measuring accuracy 0.5 %

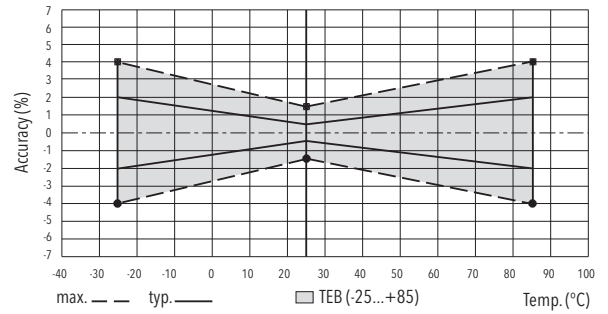

Measuring accuracy 0.3 %

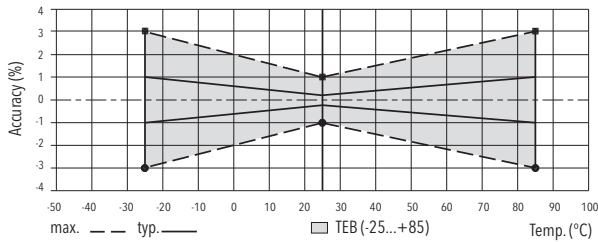

Electrical connection

		Protection / electrical connection							
		IP65 ^{*)}	IP67 ^{*)}	IP67 ^{*)}	IP65	IP68 max. 3m	IP68 max. 3m		
		Industrial standard EN175301-803A ^{**)}	M12x1 ^{**)} 5-pole	Packard Metri Pack ^{**)} 3-pole	Industrial standard Contact distance 9.4 mm ^{**)}	Cable ^{**)}	Cable ^{**)}		
		05	35	51	01	24/22	08		
Output signal	<p>8473.xx.xxxx.xx.19</p>	Standard	92	Standard	94		E4		
	<p>8473.xx.xxxx.xx.14/16/17/23</p>	Standard	98	97			99	E3	
		2 1 ⊕ ⊖	1 2 ⊕ ⊖	4 1 3 5	1 3 2 5	1 1 2 3 ⊕ ⊖	2 1 3 3 ⊕ ⊖	white brown yellow	red black green
		2 3 1 1 ⊕ ⊖	3 1 2 ⊕ ⊖	2 4 3 5	1 3 2 3	1 2 3 ⊕ ⊖	3 1 2 ⊕ ⊖	white green brown yellow	red white black green

^{*)} Provided female connector is mounted according to instructions
^{**)} Ventilation via male electric plug/cable end
^{***)} Only cable versions or female electrical plug with shield connection

Additional information		
Documents	Data sheet	www.trafag.com/H72326
	Instructions	www.trafag.com/H73324
	Flyer	www.trafag.com/H70663

Dimensions

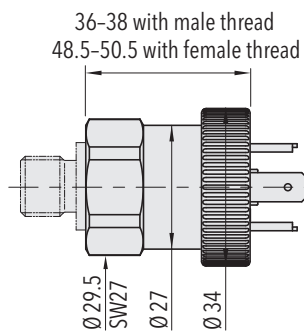

8473.XX.XXXX.05.XX.XX

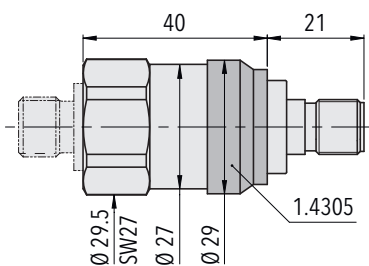

8473.XX.XXXX.35.XX.XX

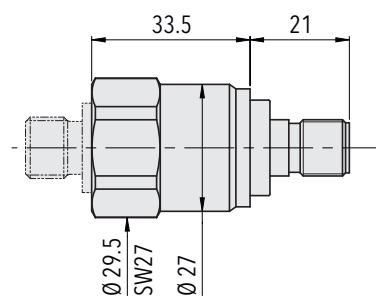

8473.XX.X717.35.XX.XX
8473.XX.X942.35.XX.XX

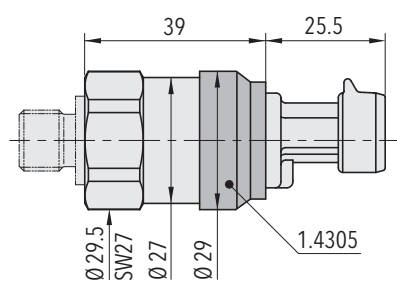

8473.XX.XXXX.51.XX.XX

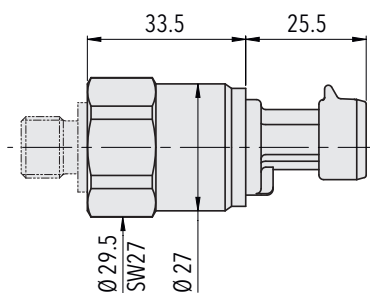

8473.XX.X717.51.XX.XX
8473.XX.X942.51.XX.XX

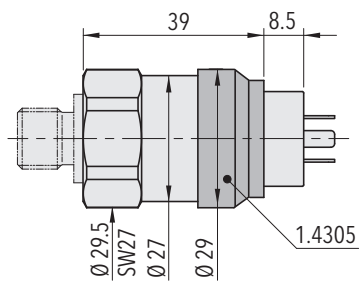

8473.XX.XXXX.01.XX.XX

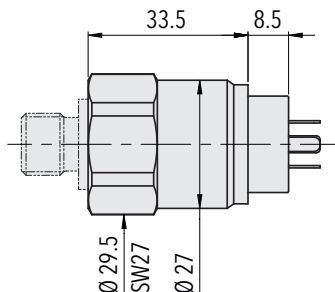

8473.XX.X717.01.XX.XX
8473.XX.X942.01.XX.XX

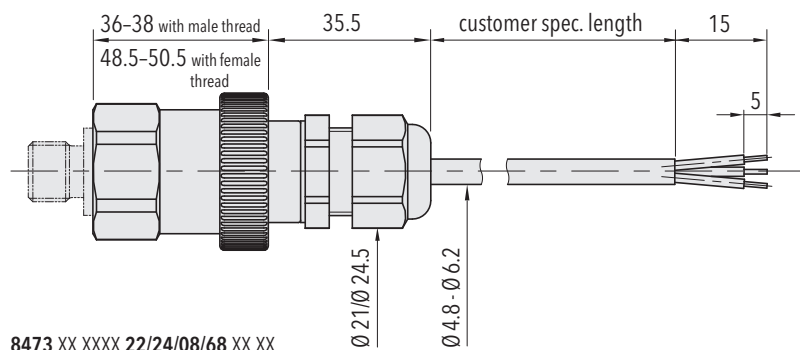

8473.XX.XXXX.22/24/08/68.XX.XX

Dimensions

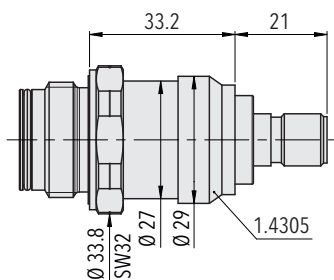

8473.XX.XX52.35.XX.XX

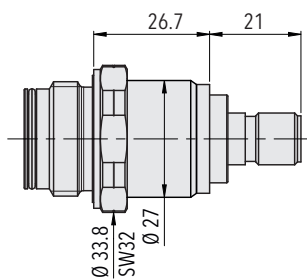

8473.XX.XX52.35.XX.XX

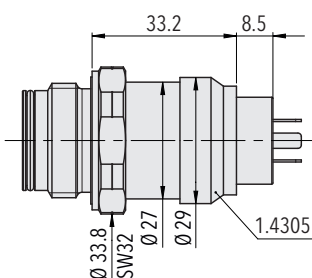

8473.XX.XX52.01.XX.XX

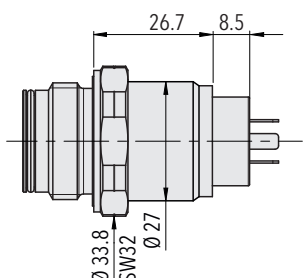

8473.XX.XX52.01.XX.XX

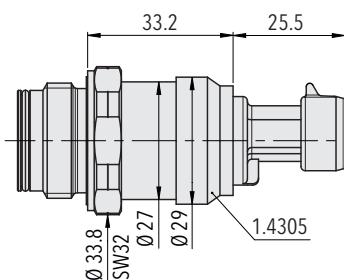

8473.XX.XX52.51.XX.XX

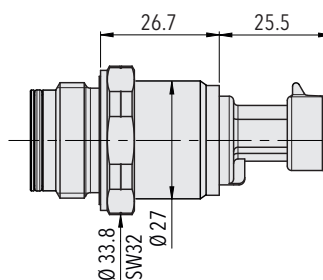

8473.XX.XX52.51.XX.XX

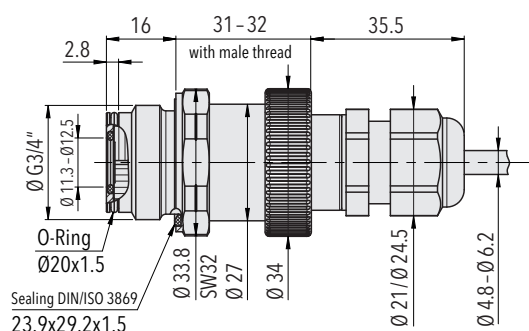

8473.XX.XX52.22/24/08.XX.XX

Dimensions

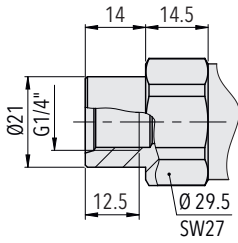

8473.XX.XX10.XX.XX.XX

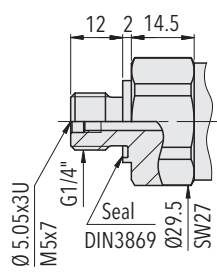

8473.XX.XX17.XX.XX.XX

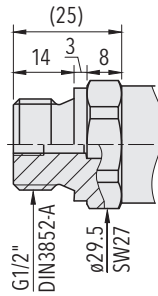

8473.XX.XX21.XX.XX.XX

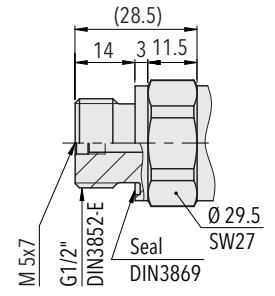

8473.XX.XX41.XX.XX.XX

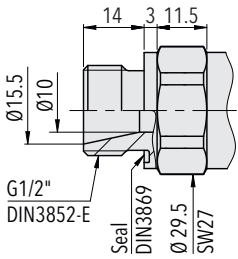

8473.XX.XX59.XX.XX.XX

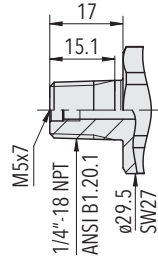

8473.XX.XX30.XX.XX.XX

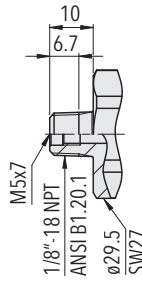

8473.XX.X643.XX.XX.XX

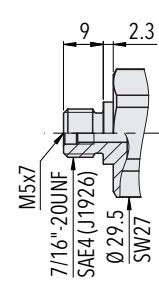

8473.XX.XX42.XX.XX.XX

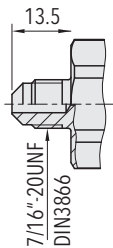

8473.XX.XX18.XX.XX.XX

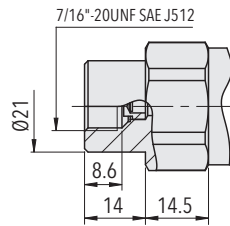

8473.XX.XX24.XX.XX.XX

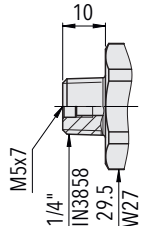

8473.XX.XX19.XX.XX.XX

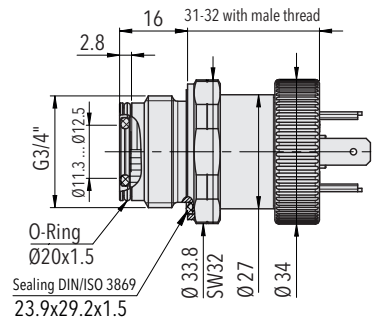
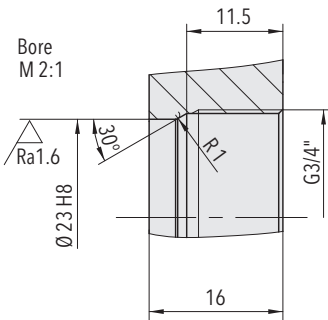

8473.XX.XX52.05.XX.XX

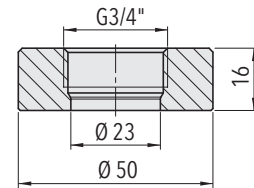

Welding flange for G3/4" frontal membrane (1.4301)
Ordering No. C27805

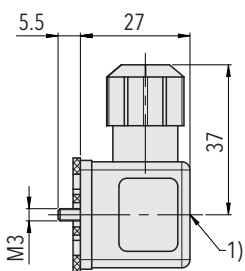

1) Tightening torque 50...60 Ncm

8473.XX.XXXX.XX.XX.46/56

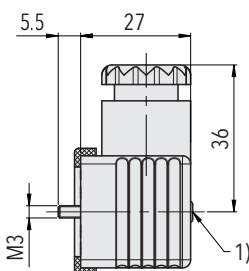

1) Tightening torque 50...60 Ncm

8473.XX.XXXX.XX.XX.58

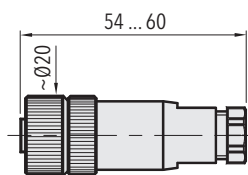

8473.XX.XXXX.XX.XX.33

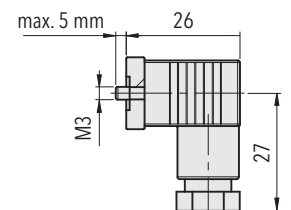

8473.XX.XXXX.XX.XX.34