



The most
advanced and versatile
Safety
Light
Curtain

F3SG-SR/PG SERIES



Redefining safety at manufacturing sites

We developed our F3SG-SR/PG Series light curtain to help manufacturers overcome the challenges of globalization and flexible production. This series offers a complete lineup of products that comply with global safety standards and provide a wide range of functionality across all design and maintenance needs, enabling manufacturers to construct state-of-the-art safety systems.



Build flexible safety systems

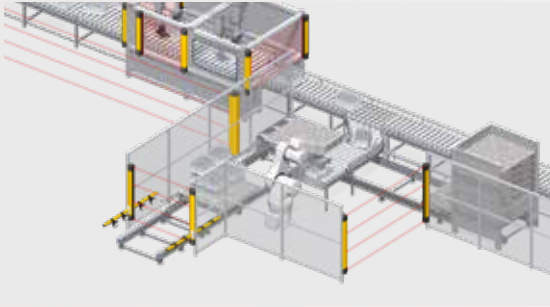

Design

- Easy design of line safety Page 4
- Flexible design for equipment Page 6

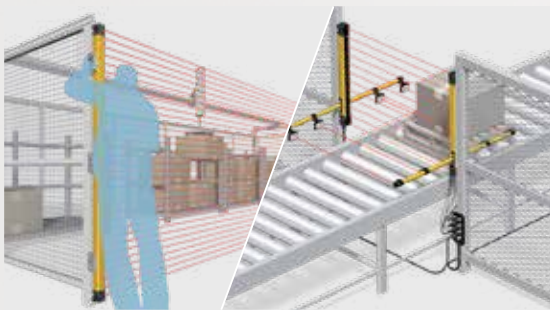

Set-up

- Simple beam adjustment Page 10
- Easy installation and angle adjustment Page 11
- Various options to reduce wiring Page 12

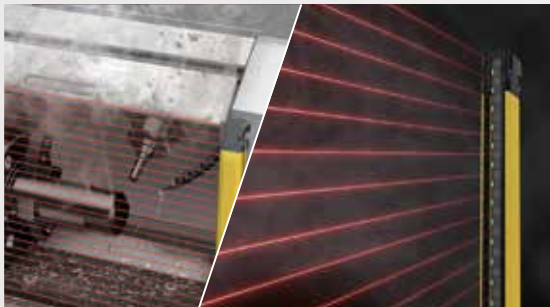

Operation

- Reduction in unwanted machine stoppages Page 14



Maintenance

- Maintenance with no special skills required Page 16
- Quick maintenance through ICT Page 17

Easy design of line safety

One series covers all protection applications—from machine openings to perimeter protection

Standardize mechanical design across production lines and eliminate complexity of selection and design.

Protection at machine openings

Safety Light Curtain
F3SG-SR

NEW

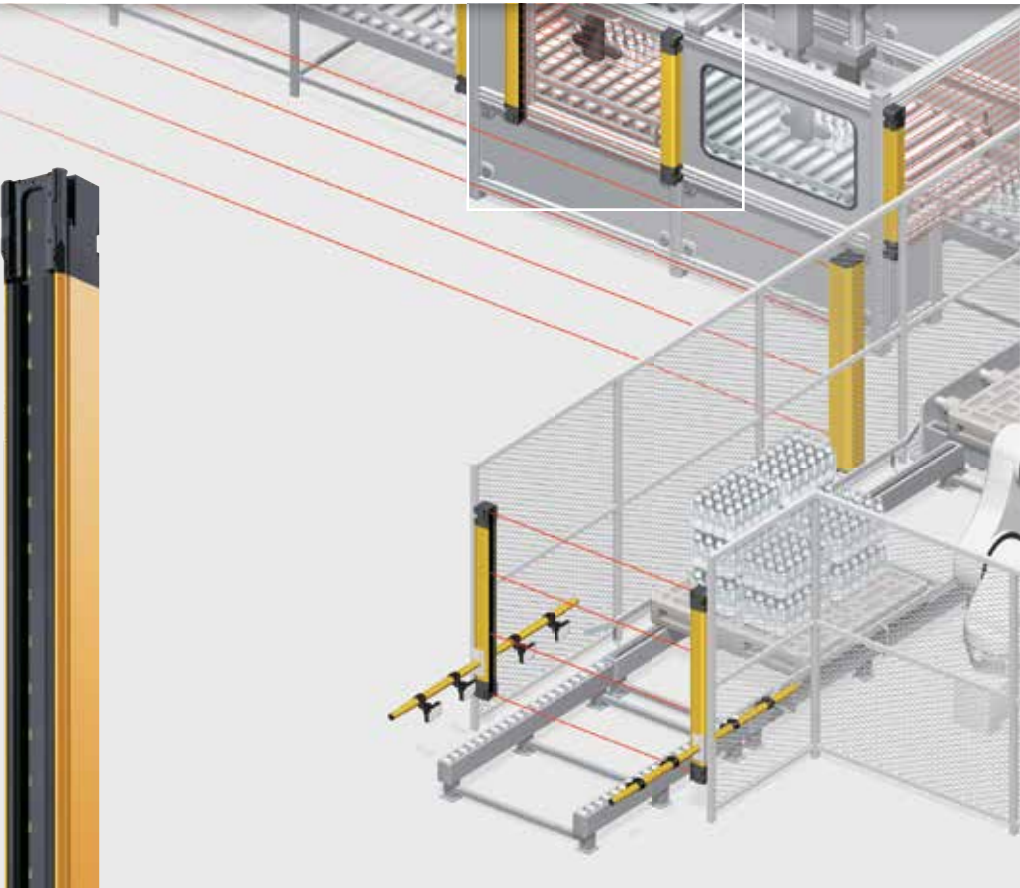

Finger Protection

Beam gap	10 mm	Detection capability 14-mm dia.
Protective height	160 to 2,000 mm	
Max. operating range	10 m	

Hand Protection

Beam gap	20 mm	Detection capability 25-mm dia.
Protective height	160 to 2,480 mm	
Max. operating range	20 m	

Arm/Leg Protection

Beam gap	40 mm	Detection capability 45-mm dia.
Protective height	240 to 1,520 mm	
Max. operating range	20 m	

Body Protection

Beam gap	80 mm	Detection capability 85-mm dia.
Protective height	280 to 920 mm	
Max. operating range	20 m	

Common accessories including cables and brackets*

The light curtains share common accessories for ease of design and retrofitting of production lines.

Intelligent Tap

F39-SGIT-IL3

Bluetooth® Communication Unit

F39-SGBT

IO-Link

Bluetooth®

USB Type-C™



Y-Joint Plug/

Socket Connector

F39-GCNY2



Muting Sensor Arm Mounter

F39-FMA

Available early 2020



Muting Sensor

Connection Box

F39-GCN5

Available early 2020



Floor Mount Column

F39-ST

Available early 2020



Mount-Column

Adjustable Base

F39-STB

Available early 2020

Mirror Column

(for F3SG-SR

Safety

Light Curtain)

F39-SML

Available early 2020



*1 Except for some accessories. See page 37 and following for details.

Perimeter Protection
Safety Multi-Light Beam
F3SG-PG

Available early 2020

Perimeter Access Guarding	Perimeter Guarding Long Range	Perimeter Guarding Mirror
Beam gap: 300/400/500 mm	Beam gap: 300/400/500 mm	Beam gap: 300/400/500 mm
Protective height: 580 to 1,280 mm	Protective height: 580 to 1,280 mm	Protective height: 580 to 1,280 mm
Max. operating range: 20 m	Max. operating range: 70 m	Max. operating range: 6~10 m

Mirror Column
(for F3SG-PG
Safety
Multi-Light Beam)
F39-PML

Available early 2020



Helps build safety systems for machines all over the world

Certification to worldwide safety standards*.

* We will apply for GB, TS Mark, S Mark, and KCs Mark.



PNP/NPN selection for global compatibility



IP67G water and oil resistance and IP69K*.

Available early 2020



Flexible design to fit your equipment

Broad industry lineup to meet your needs for flexible production line design

Long operating range thanks to unique optical design

The long-distance sensing capability enables reliable detection even in harsh environments.

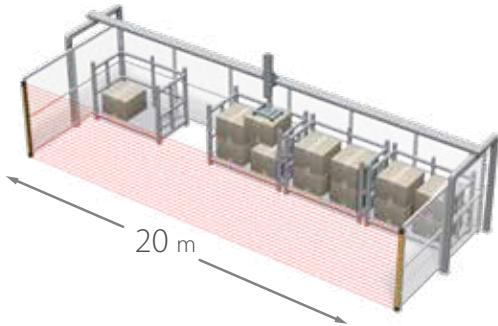

Safety Light Curtain
F3SG-SR
Series

20 m

Longest range for hand protection

The high-power optical system provides stable detection up to 20 m even in harsh environments.

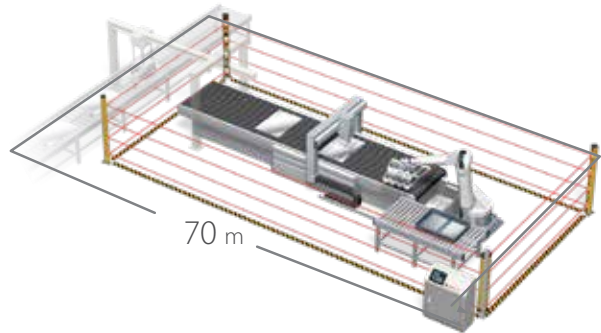

Safety Multi-Light Beam
F3SG-PG
Series

70 m

Patent pending

The unique multi-beam optical design achieves a maximum operating range of 70 m*.

* F3SG-PG Perimeter Guarding Long Range



Omron's unique compact design

The F3SG-SR Safety Light Curtain and F3SG-PG Safety Multi-Light beam share the same compact housing, making the mechanical design more flexible.

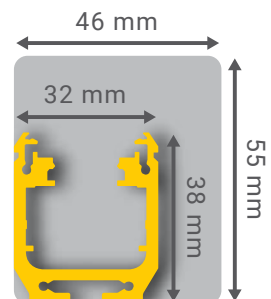

Easy line layout changes

Simply replace a light curtain using the same accessories because the F3SG-SR Series and F3SG-PG Series share the same housing. There is no need to install different accessories for the new light curtain.

Example : In order to secure a larger working space by installing the light curtain closer to the machine, the perimeter guarding model is replaced with the finger protection model

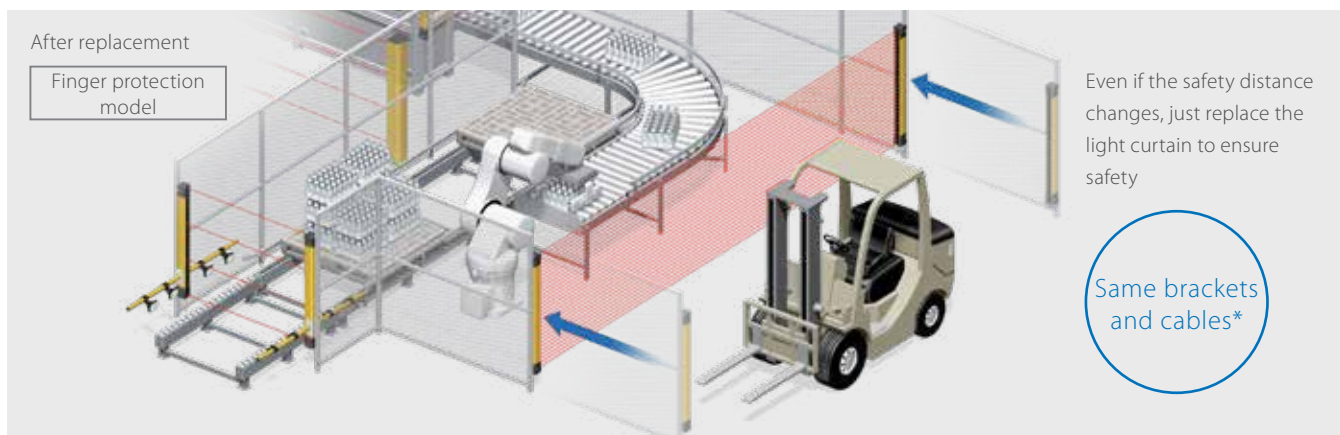
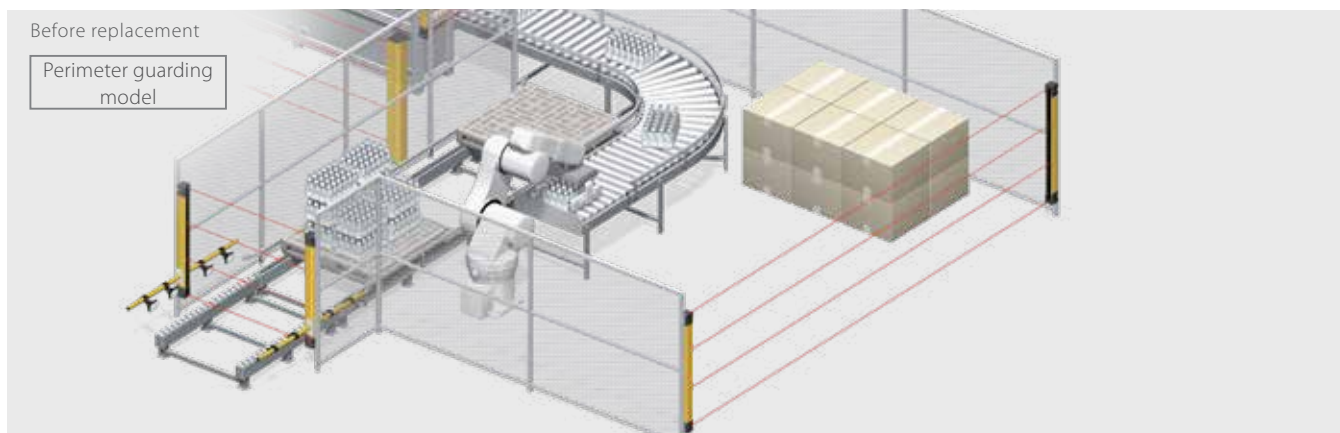

Just replace the light curtain with the same protective height*

F3SG-SR Series lineup

● Standard model ○ Flexible height model (Increments of 40 mm)

Protective height (mm)	160	200	240	280	320	360	400	440	480	520	560	580	600	640	680	720	760	800	840	880	920	960	980	1000	1040	1120	1200	1280
Finger Protection	●	○	●	○	●	○	●	○	●	○	●	○	●	○	●	○	●	○	●	○	●	○	●	○	●	○	●	○
Hand Protection	●	○	●	○	●	○	●	○	●	○	●	○	●	○	●	○	●	○	●	○	●	○	●	○	●	○	●	○
Arm/Leg Protection			●				●				●					●					●							●
Body Protection																●						●						

Protective height (mm)	1360	1400	1440	1520	1600	1680	1760	1800	1840	1920	2000	2080	2280	2480
Finger Protection	●	○	●	○	●	○	●	○	●	○	●	○	●	○
Hand Protection	●	○	●	○	●	○	●	○	●	○	●	○	●	○
Arm/Leg Protection				●										
Body Protection														

F3SG-PG Series lineup

Protective height (mm)	160	200	240	280	320	360	400	440	480	520	560	580	600	640	680	720	760	800	840	880	920	960	980	1000	1040	1120	1200	1280
Perimeter Access Guarding												●									●							●
Perimeter Guarding Long Range												●									●							●
Perimeter Guarding Deflect Mirror												●									●							●

* Except for some models and accessories. See page 37 and following for details.

Flexible design to fit your equipment

Perfect fit

Protective heights are available in increments of 40 mm up to 1,000 mm*. The perfect protective height for any area ensures safety and eliminates the need for additional protective measures.

Problem

The light curtain that does not completely fit the protected area requires additional measures (e.g., adding a protection cover).

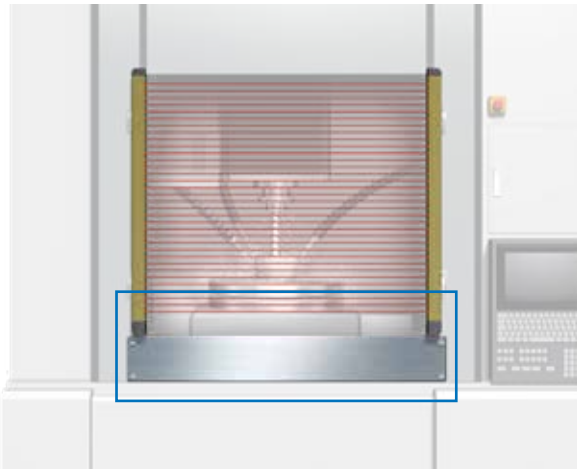

F3SG-SR*

The flexible height model requires no additional guarding saving installing time and money.

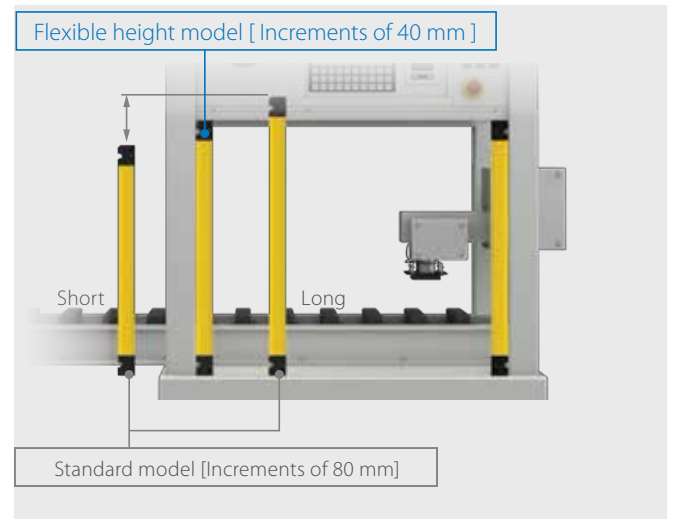

* F3SG-SR Finger and Hand Protection models only.

No dead space

The F3SG-SR Series eliminates dead space even when light curtains are series-connected or U-shape connected.

Problem

Dead space exists at the joint.

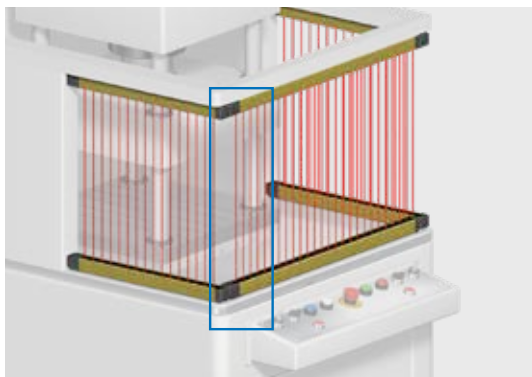

F3SG-SR*

Eliminates dead space and ensures safety.

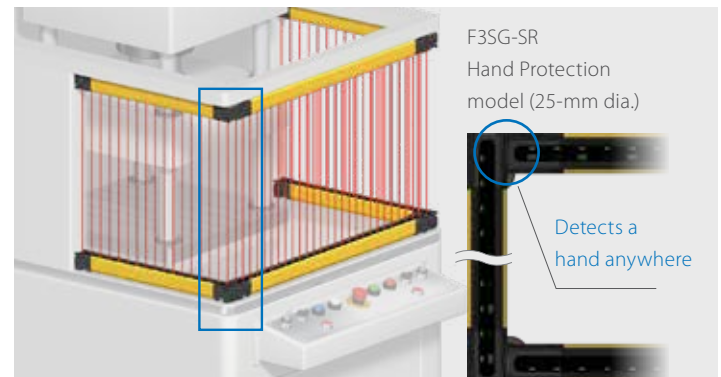

* Except for F3SG-SR Finger Protection models.

Reduced wiring for flexible design

To protect the perimeter of equipment, the F3SG-PG series offers the emitter/receiver in one housing for a reduction in wiring and installation time.

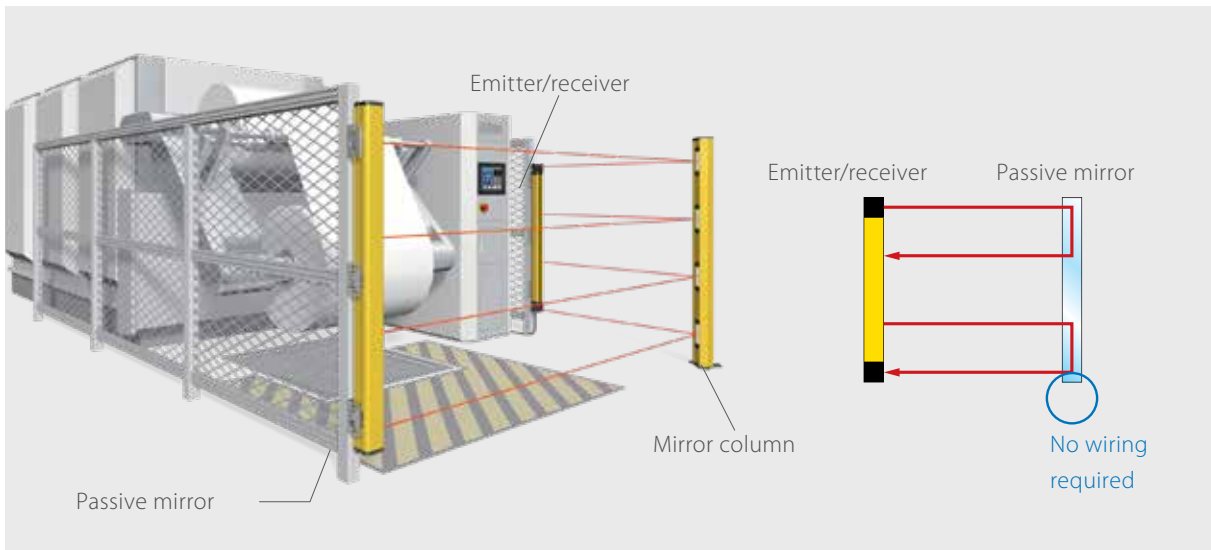

Two different synchronization systems

Choose from two different methods of synchronization between the emitter and receiver to suit your equipment.

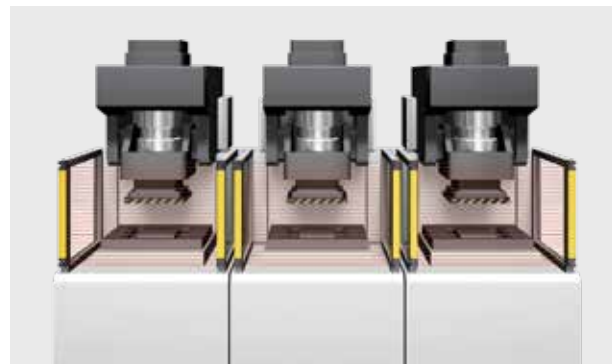
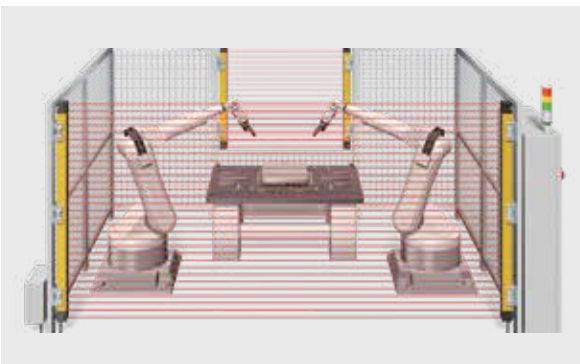

Optical synchronization
 No sync lines are required.
 Connect emitter only to power supply.
 Mutual interference prevention : Up to 2 sets

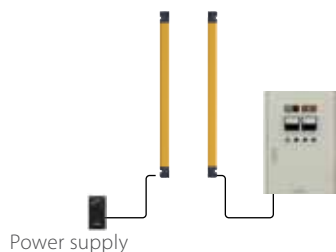

Wired synchronization
 Mutual interference prevention: Up to 3 sets



Quick and easy beam adjustment

Color indication of beam status simplifies adjustment and saves time

Area Beam Indicator (ABI) for an at-a-glance check of beam status

Patent pending

ON/OFF status of the light curtain plus low light intensity indicators provide immediate beam status.

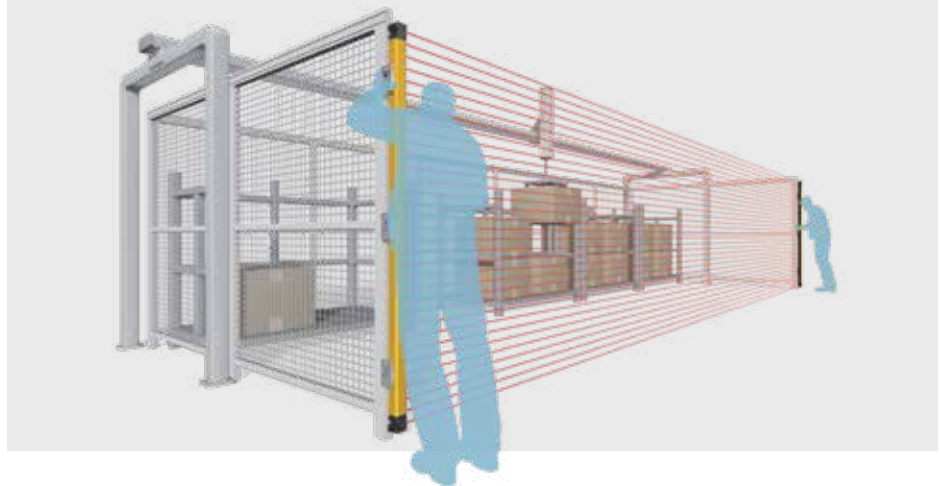

Easy to see



Stable state
Green :
Safety outputs ON
The beams are unblocked.



Low light intensity
Orange :
Safety outputs ON
Adjust beams or check if the light curtain is dirty.



Beams blocked
Red :
Safety outputs OFF*
The beams in the area are blocked.

* The indicator of an unblocked area is OFF.

The images of indicator illumination may vary somewhat from the actual products.

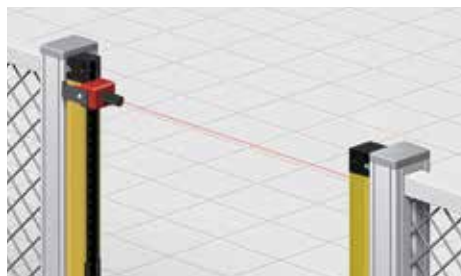

Laser Alignment
Pointer
F39-PTG



Assists with beam adjustment.
Easy-to-see laser beam shows the sensor orientation.

Easy installation and angle adjustment

Multiple accessory options to reduce installation time
Simplify angle adjustment without relying on advanced engineering expertise

Easy beam adjustment after installation

Problem

When using a protective cover, it is difficult to adjust the beams after installation.



F3SG-SR/PG

The rugged metal housing of the light curtain does not need a protection cover. Beams can be adjusted using optional brackets.



Adjustable Top / Bottom Bracket
F3SJ, F3SN Adapter
F39-LSGTB-SJ

This bracket used at the top and bottom of the light curtain provides horizontal adjustment of $\pm 22.5^\circ$.

Adjustable Side-Mount Bracket (Intermediate Bracket)
F39-LSGA

This bracket provides horizontal adjustment of $\pm 15^\circ$ as well as vertical position adjustment.

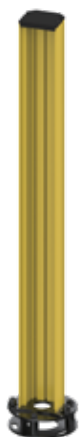

Floor Mount Column

F39-ST Available early 2020

This column can be installed independently of equipment or fences, almost anywhere.

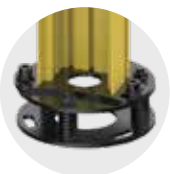
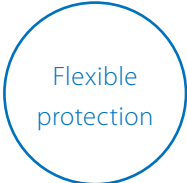

Mount-Column Adjustable Base
F39-STB

Available early 2020

Intelligent Tap

F39-SGIT-IL3

Settings can be copied between light curtains without using a PC, reducing time and effort.

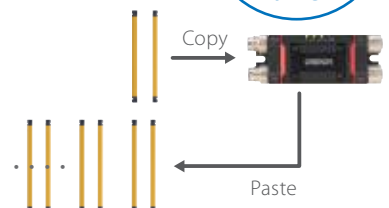
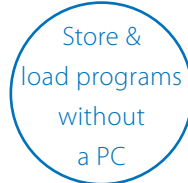

Options to reduce wiring costs

Reduction in wiring minimizes installation costs

Simple wiring around large equipment

Problem

Long wire runs can be problematic and costly.

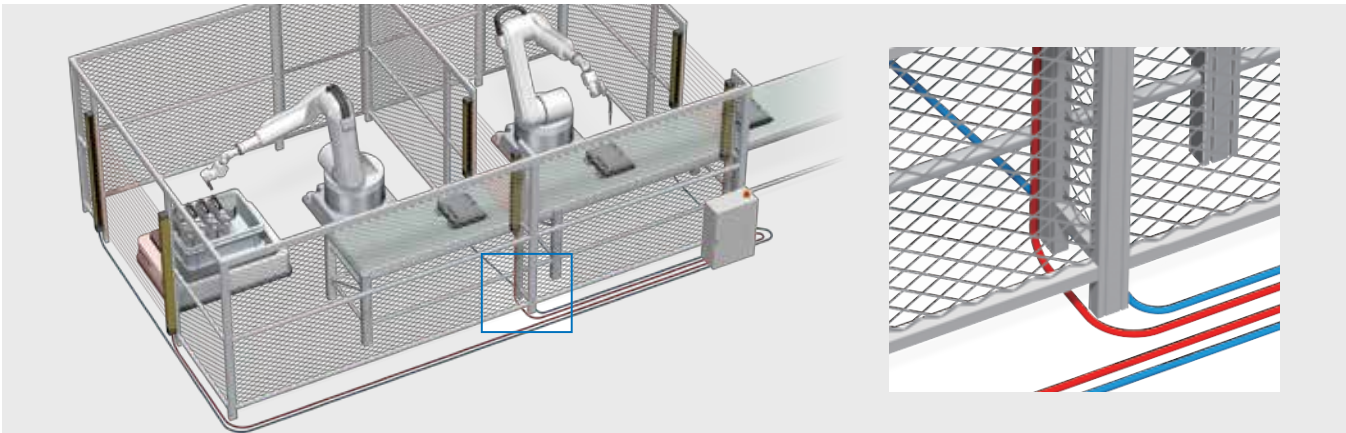

F3SG-SR/PG

The reduced wiring system lessens the number of cables and terminal blocks as well as wiring time.

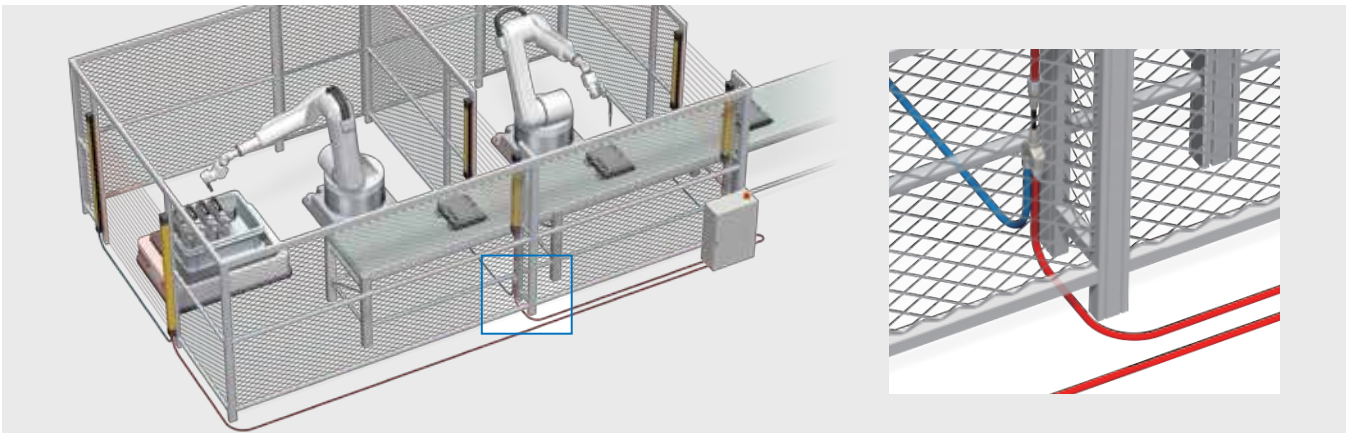

Reduced wiring connector



Y-Joint Plug/
Socket Connector
F39-GCNY2

Emitter Receiver



13-pair terminals

Emitter Receiver

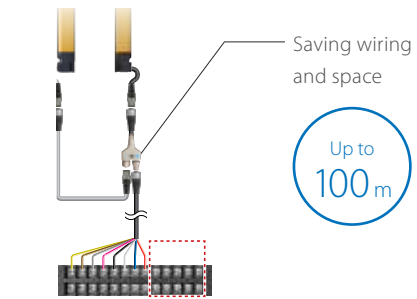

8-pair terminals

One cable connection to control panel

Options provide simple wiring for muting.

Problem

Light curtains are often used with muting sensors, complicating the wiring in control panel.

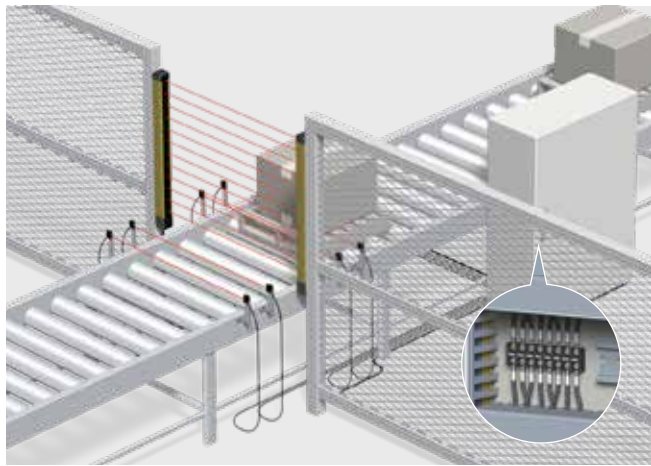

F3SG-SR/PG

Options to reduce wiring simplify wiring and installation of muting sensors.

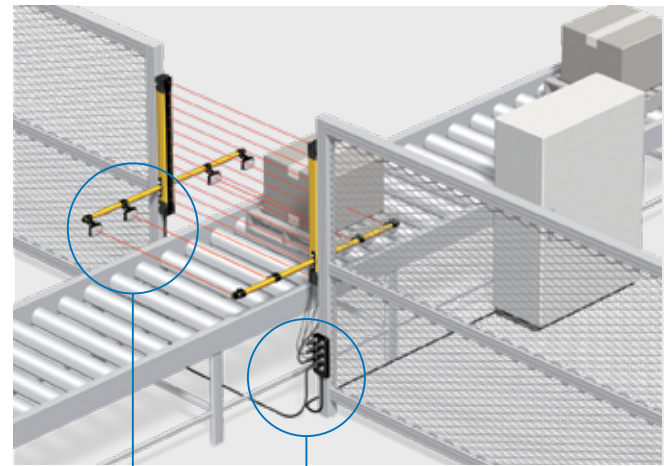

Muting Sensor Mounting Arm Brackets

F39-FMA Available early 2020

The muting sensor mounting arm brackets facilitates installation of a muting sensor.

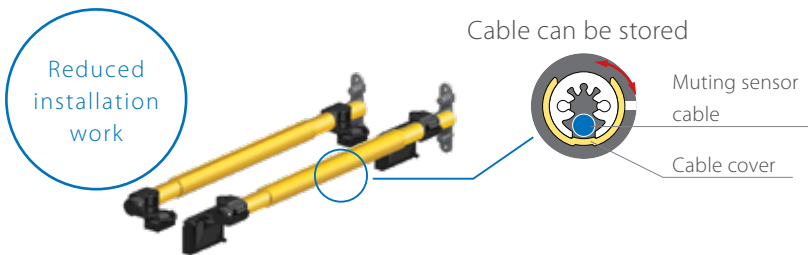

Muting Sensor Connection Box

F39-GCN5 Available early 2020

The connection box simplifies wiring for muting, and only one cable to connect to the control panel.



Note : The E3Z Muting Sensor is sold separately.

Smartclick connectors to quickly connect cables



Smartclick is a registered trademark of OMRON Corporation.

Reduction in unwanted machine stoppages

Robust design ensures stable operation in any environment

Light curtains tend to malfunction in harsh environments



Cold storage warehouse

Safety measures cannot be implemented because there is no light curtain that can be used in cold environments.

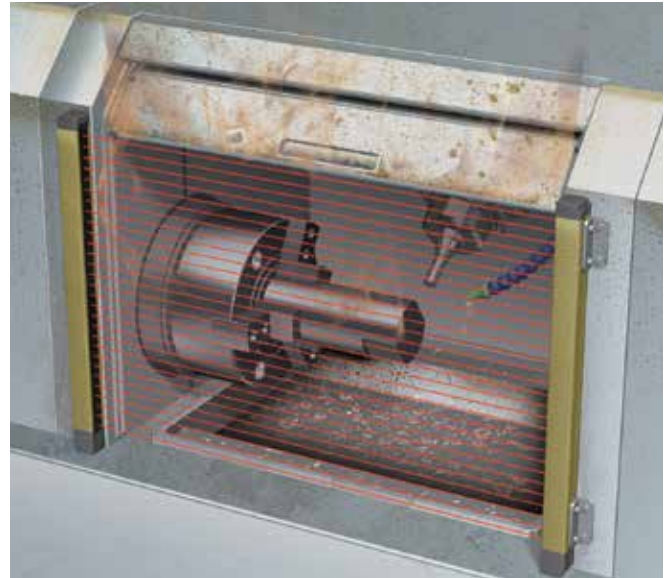

Metal working process

Oil mist penetrates the light curtain causing a failure.

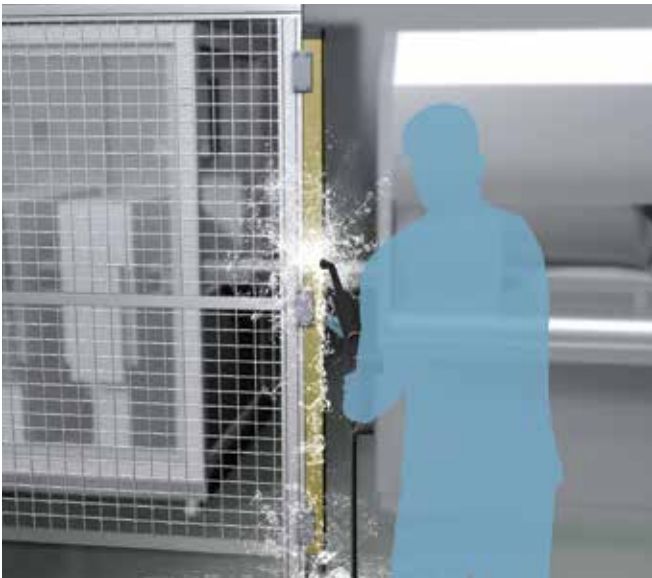

Food processing line

Cleaning solution that gets inside the light curtain during machine wash-down causes failure.



Use in harsh environments

The spattered or dusty optical surface of the light curtain causes a malfunction and sudden machine stop.

Use in temperatures down to -30°C

Water/oil resistance IP67G

Tightly sealed structure improves environmental resistance

This unique housing structure firmly compresses the optical surface, ensuring a leak proof seal, which improves the environmental resistance of the housing.

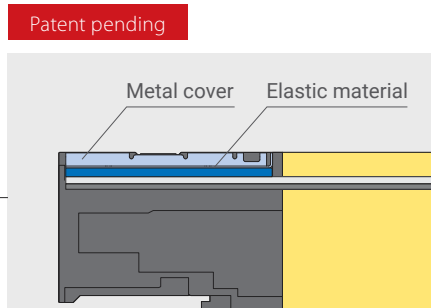

Technology 1 to tightly seal the cap

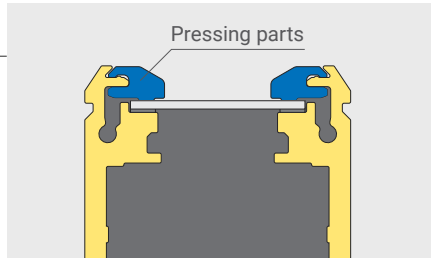

Technology 2 to tightly seal the housing

IP69K model for high-pressure wash-down applications

Available early 2020



Water resistance IP69K

High-power optical system provides stable detection



The maximum operating range of the F3SG-SR Safety Light Curtain is 20 m and the F3SG-PG Safety Multi-Light Beam is 70 m.

Metal housing increases ruggedness

Laser marked information withstands harsh environments

Straightforward Maintenance

Even inexperienced operators can easily check status and replace light curtains

Color indicators provide for clear error diagnosis

The light curtain status can be checked at a glance.



Status indicator

Clear LED indicators with labels help perform predictive maintenance by dirt detection and determine the optimal replacement timing.

Colors and patterns indicate the status

Status indicator	Color	Status
	Red/ Illuminated	LOCKOUT state due to a recoverable error
	Red/ Blinking	LOCKOUT state due to a replacement-recommended error
	Orange/ Illuminated	Safety outputs are instantaneously turned OFF due to ambient light, vibration, or noise
	Orange/ Blinking	The Intelligent Tap is in LOCKOUT state

For information on other indicators, refer to Indicator on page 63 or Troubleshooting on page 95.

Lamp

Output status can be checked at a glance.

Available early 2020

F39-SGLP



Output information can be assigned to the lamp and ABI.



Status, such as light intensity drop, can be checked from a distance.

Back up and restore settings with Intelligent Tap

Replacement and setting time during maintenance can be reduced by 90%.*1

Plug & Work for quick replacement

Install the Intelligent Tap to automatically copy the settings of a light curtain to a new one.

Virtually anyone can easily replace light curtains and immediately restart the machine.

Replacement and setting time reduced by 90%



Intelligent Tap
F39-SGIT-IL3



ICT facilitates more detailed data monitoring

There is no need for a PC on site to check status

Easy remote monitoring

Various devices can be connected via IO-Link.*1

IO-Link



No PC required on site

Note : Screen images for illustration purposes only.

Easy on-site monitoring

The Bluetooth communication unit allows you to monitor information about device stoppages on mobile devices.



Bluetooth®

SD Manager 3
Mobile APP

Process data

- Auxiliary output status *2
- Muting input status
- Sequence error information
- Unstable state information (each ch)
- Power voltage information
- OSSD output status
- Reset/EDM/override input status
- Instantaneous block information (each ch)
- Light curtain/Intelligent Tap lockout information

Requirements

Android™ 7.0 or higher
Windows® 10



Startup screen



Error log screen



Light level monitoring

Service data

- Light curtain information
- Light intensity information (1 byte: 0-255)
- Light curtain settings
- Light curtain internal status information
- Intelligent Tap power-on time information
- Intelligent Tap information
- Error log (4 errors)

System configuration example



*1 Refer to the IO-Link Series Catalog (Cat. No. Y229) for details.

*2 Auxiliary output can be set using the SD Manager 3.

Easy setting via PC software

SD Manager 3

The configuration tool allows you to easily monitor status and make settings without using a safety controller. →



Manually loaded machining : PSDI



PSDI*, provided as standard, reduces operator effort and increases productivity

There is no need for the operator to press a two-hand control switch, saving operating time and increasing operating efficiency.

Single break

The machine restarts when the light curtain is interrupted and reset once.

Example : Manual loading and automatic unloading press

Double break

The machine restarts when the interruption and reset are repeated twice.

Example : Manual loading and manual unloading press

* PSDI : Presence Sensing Device Initiation

Read the User's Manual (Cat. No. Z405) before using.

Note: Comply with laws and regulations in the countries where the machine operates.

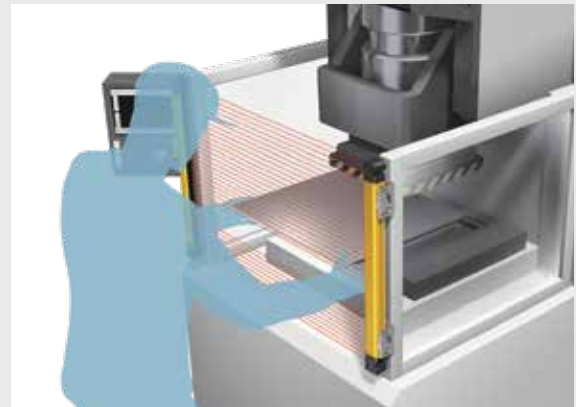

Dangerous restart prevention : Pre-Reset



The Pre-Reset function prevents possible accidents

This function prevents the restart of equipment while an unseen worker is still near the robot, ensuring operators' safety.

- 1 Press the pre-reset switch inside the hazardous zone.
- 2 Get out of the hazardous zone.
- 3 Press the reset switch in the control panel to restart the light curtain.
The machine is ready for restart.

The equipment cannot be restarted until the pre-reset switch of the light curtain is pressed and the light curtain is reset.

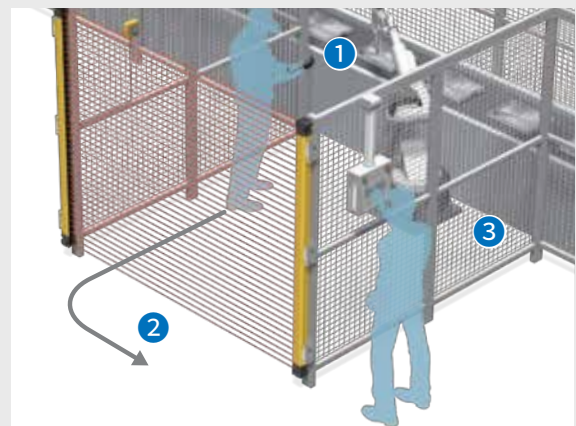

Ignoring interrupted beams : Reduced Resolution



Reduced Resolution changes the detection capability of the light curtain

Even when objects (with a size of 1 to 3 interrupted beams) are present, this function ignores them and keeps the safety outputs ON. This helps maintain productivity.

Example : Arm and body protection

Safety output is kept ON even if worker's finger and an object interrupt 2 beams because they are allowed to enter.



When worker's arm or body, which interrupts 3 beams is detected, safety output is turned OFF.

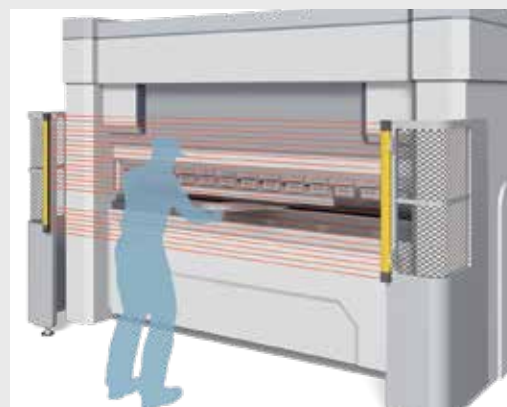

Note : Ensure that the desired safety distance is maintained.

Built-in standard safety functions

Monitoring



Incident/Ambient Light Level Information

Safety function setting

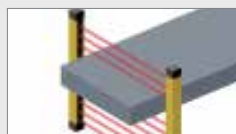

Fixed Blanking



Floating Blanking

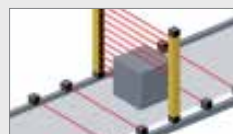

Muting/Override



Warning Zone

I/O setting

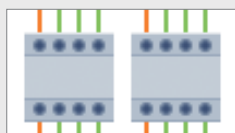

Interlock/External Device Monitoring



Teach-in Input



External Test Input

Operation state change

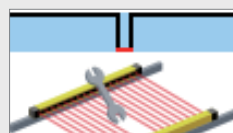









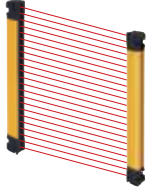
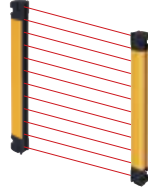
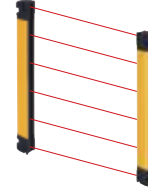
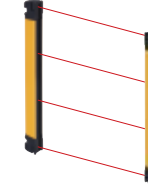

















Response Time Adjustment











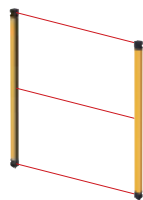
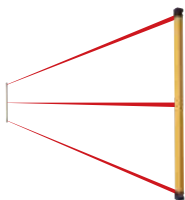
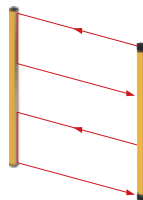











Operating Range Selection

F3SG-SR/PG Series Features and Specifications

Series		Protection at machine openings : Safety Light Curtain F3SG-SR				
		Advanced/Standard				
						
Application	 Finger Protection					
	 Hand Protection					
	 Arm/Leg Protection					
	 Body Protection					
Specification	Detection capability	14-mm dia.	25-mm dia.	45-mm dia.	85-mm dia.	
	Beam gap	10 mm	20 mm	40 mm	80 mm	
	Max. operating range	10 m	20 m	20 m	20 m	
	Protective height	160 to 2,000 mm	160 to 2,480 mm	240 to 1,520 mm	280 to 920 mm	
	Number of beams	15 to 199	8 to 124	6 to 38	4 to 12	
	Degree of protection	IP65, IP67, and IP67G				
Feature	Mutual interference prevention	 (No settings required for wired synchronization)				
	PNP/NPN Selection					
	External Test					
	Interlock					
	Reset					
	Pre-Reset					
	PSDI					
	External Device Monitoring (EDM)					
	Auxiliary Output					
	Muting					
	Blanking					
	Reduced Resolution					
	Warning Zone					
	Operating Range Selection					
	Response Time Adjustment					
	Area Beam Indicator (ABI)	 * Advanced models only				
Designated Beam Output						
Connection/ wiring	Cascade connection	Available	Available	Available	Available	
	Reduced wiring system*1	Available	Available	Available	Available	
Accessory	Laser Alignment Pointer	Available	Available	Available	Available	
	Lamp Available early 2020	Available	Available	Available	Available	
	IP69K model Available early 2020	Available	Available	Not available	Not available	

 Setting by DIP switch on Intelligent Tap  Setting by configuration tool SD Manager 3  Setting by wiring  Setting by end cap

Protection around perimeters of equipment : Safety Multi-Light Beam F3SG-PG Available early 2020				Series	
Perimeter Access Guarding	Perimeter Guarding Long Range	Perimeter Guarding Deflect Mirror	Application		
					 Finger Protection
			 Hand Protection		
			 Arm/Leg Protection		
			 Body Protection	Specification	
---			Detection capability		
300 mm/400 mm/500 mm			Beam gap		
20 m	70 m	6 to 10 m *2	Max. operating range		
580 to 1,280 mm			Protective height		
2 to 4			Number of beams		
IP65 and IP67			Degree of protection		
 (No settings required for wired synchronization)			Mutual interference prevention	Feature	
			PNP/NPN Selection		
 Not supported			External Test		
			Interlock		
			Reset		
			Pre-Reset		
Not supported			PSDI		
			External Device Monitoring (EDM)		
			Auxiliary Output		
			Muting		
Not supported			Blanking		
Not supported			Reduced Resolution		
Not supported			Warning Zone		
 Not supported			Operating Range Selection		
			Response Time Adjustment		
			Area Beam Indicator (ABI)		
			Designated Beam Output		
Not available	Not available	Not available	Cascade connection	Connection/ wiring	
Available	Available	Available	Reduced wiring system*1		
Available	Available	Available *3	Laser Alignment Pointer	Accessory	
Available	Available	Available *3	Lamp Available early 2020		
Available	Not available	Not available	IP69K model Available early 2020		

*1. The reduced wiring system includes the Y-joint plug/socket connector, reset switch connector, and muting sensor connection box (available soon).

*2. Varies depending on the model.

*3. Cannot be mounted on the passive mirror.

F3SG-SR/PG Series Product Selection

Choose your safety light curtain and accessories from our F3SG Series through a 4-step process

STEP 1

Choose a safety light curtain

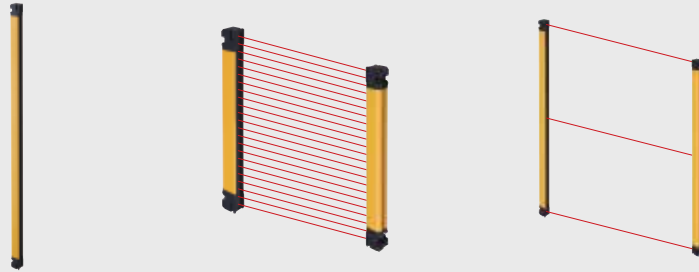

STEP 2

Choose a mounting bracket

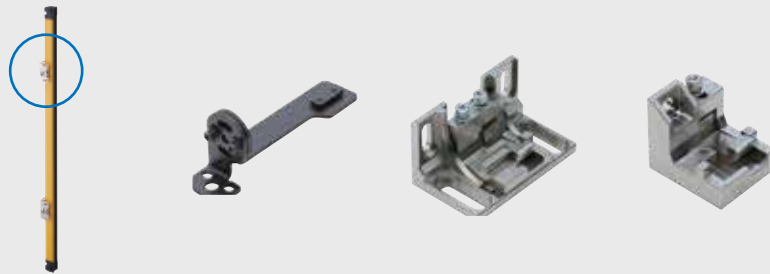

STEP 3

Choose a wiring method



STEP 4

Choose the accessories you need



Product Selection

Step 1: Choose a safety light curtain

Protection
at machine openings



Page 24

Safety Light Curtain
F3SG-SR Series

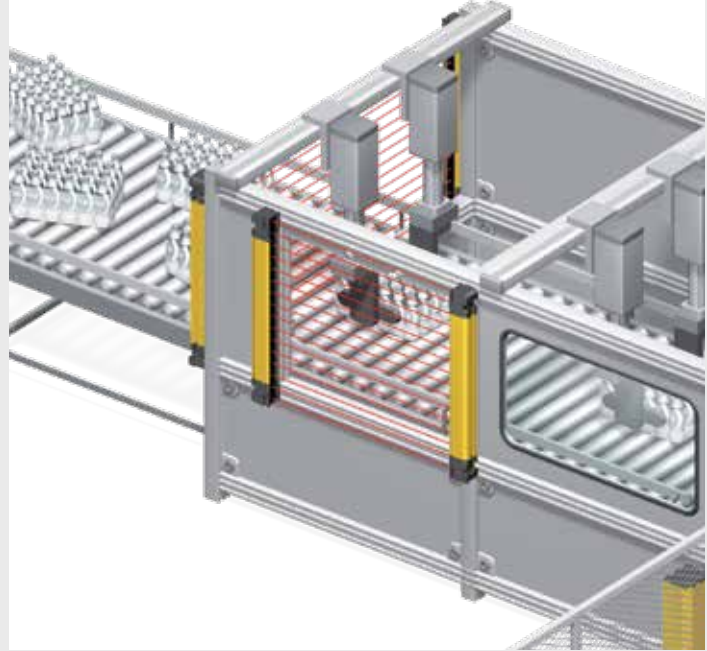

Protection around perimeters
of equipment



Page 26

Safety Multi-Light Beam
F3SG-PG Series

Available early 2020

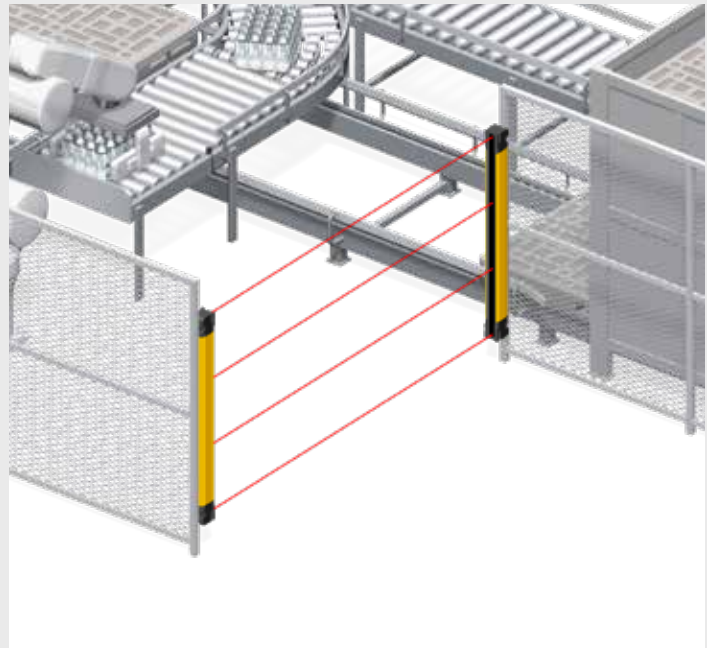



Complete the model number.

F3SG-4SR - - -

①
③
②
④
⑤

1 Select an application.

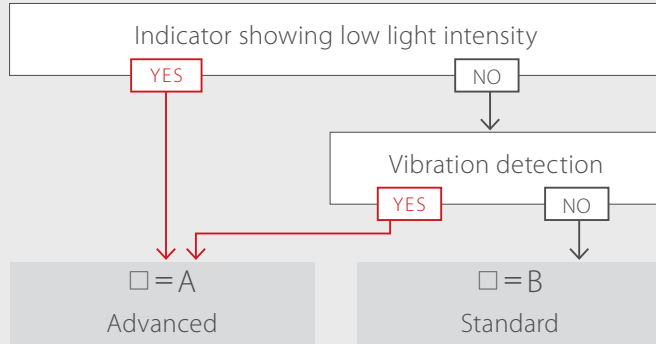

2 Select detection capability.

Type	②
<p>Finger Protection</p> <p>Detection capability 14-mm dia.</p>	□□ = 14
<p>Hand Protection</p> <p>Detection capability 25-mm dia.</p>	□□ = 25
<p>Arm/Leg Protection</p> <p>Detection capability 45-mm dia.</p>	□□ = 45
<p>Body Protection</p> <p>Detection capability 85-mm dia.</p>	□□ = 85

3 Select protective height.*

Finger Protection

Protective height (mm)	Number of beams	③
160	15	□□□□ = 0160
240	23	□□□□ = 0240
320	31	□□□□ = 0320
400	39	□□□□ = 0400
480	47	□□□□ = 0480
560	55	□□□□ = 0560
640	63	□□□□ = 0640
800	79	□□□□ = 0800
1000	99	□□□□ = 1000
1200	119	□□□□ = 1200
1400	139	□□□□ = 1400
1600	159	□□□□ = 1600
1800	179	□□□□ = 1800
2000	199	□□□□ = 2000

Arm/Leg Protection

Protective height (mm)	Number of beams	③
240	6	□□□□ = 0240
400	10	□□□□ = 0400
560	14	□□□□ = 0560
720	18	□□□□ = 0720
880	22	□□□□ = 0880
1200	30	□□□□ = 1200
1520	38	□□□□ = 1520

Body Protection

Protective height (mm)	Number of beams	③
280	4	□□□□ = 0280
440	6	□□□□ = 0440
600	8	□□□□ = 0600
760	10	□□□□ = 0760
920	12	□□□□ = 0920

Product Selection

Step 1: Choose a safety light curtain

Hand Protection

Protective height (mm)	Number of beams	③
160	8	□□□□=0160
240	12	□□□□=0240
320	16	□□□□=0320
400	20	□□□□=0400
480	24	□□□□=0480
560	28	□□□□=0560
640	32	□□□□=0640
720	36	□□□□=0720
800	40	□□□□=0800
880	44	□□□□=0880
960	48	□□□□=0960
1040	52	□□□□=1040
1120	56	□□□□=1120
1200	60	□□□□=1200
1280	64	□□□□=1280
1360	68	□□□□=1360
1440	72	□□□□=1440
1520	76	□□□□=1520
1600	80	□□□□=1600
1680	84	□□□□=1680
1760	88	□□□□=1760
1840	92	□□□□=1840
1920	96	□□□□=1920
2080	104	□□□□=2080
2280	114	□□□□=2280
2480	124	□□□□=2480

④ ⑤ Select an option.*

Type	④
Set of emitter and receiver	Blank
Emitter	<input type="checkbox"/> =L
Receiver	<input type="checkbox"/> =D

Finger Protection and Hand Protection only

Type	⑤
-	Blank
Flexible Height Model <Protective heights available in increments of 40 mm>	<input type="checkbox"/> =F

* Representative models are listed. For other models, refer to page 34 and following.



Complete the model number.

F3SG-4PGA □□□□ - □□ - □
2 1 3

1 Select an application and then select a beam gap and number of beams.

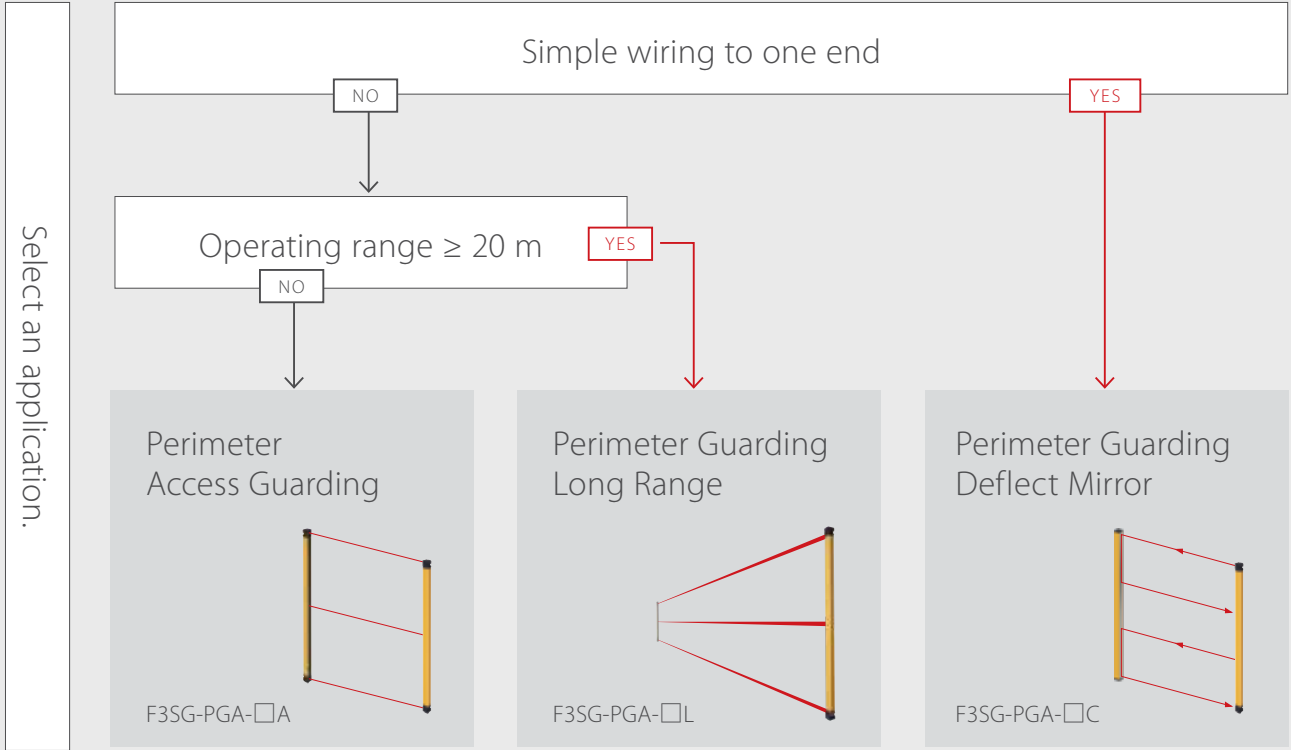

Select a beam gap and number of beams.

Beam gap/ number of beams	1	Beam gap/ number of beams	1	Beam gap/ number of beams	1
500 mm/2 beams	□□=2A	500 mm/2 beams	□□=2L	500 mm/2 beams	□□=2C
400 mm/3 beams	□□=3A	400 mm/3 beams	□□=3L	400 mm/3 beams	□□=3C
300 or 400 mm/ 4 beams	□□=4A	300 or 400 mm/ 4 beams	□□=4L	300 or 400 mm/ 4 beams	□□=4C

Product Selection

Step 1: Choose a safety light curtain

2 Select protective height.*

Protective height (mm)	Number of beams	2
580	2	□□□□=0580
880	3	□□□□=0880
980	4	□□□□=0980
1280	4	□□□□=1280

3 Select an option.

Type	3
Set of emitter and receiver, or set of emitter/receiver and passive mirror	Blank
Emitter	□=L
Receiver	□=D
Emitter/receiver (Perimeter Guarding Deflect Mirror only)	□=LD
Passive mirror (Perimeter Guarding Deflect Mirror only)	□=M

* Representative models are listed. For other models, refer to page 36 and following.

Product Selection

Step 2: Choose a mounting bracket

Side-Mount Bracket
(Intermediate Bracket)



Standard accessory



Suitable for mounting on an aluminum profile so that its center is aligned with the center of beams.

- Included as a standard accessory with the light curtain
- Side mounting and backside mounting
- Beams not adjustable after installation

[Number of provided brackets]

Protective height \leq 1,440 mm : 4

Protective height \leq 1,520 mm : 6

Brackets that allow beam adjustment after the light curtain is installed

Adjustable Side-Mount Bracket
(Intermediate Bracket)

F39-LSGA

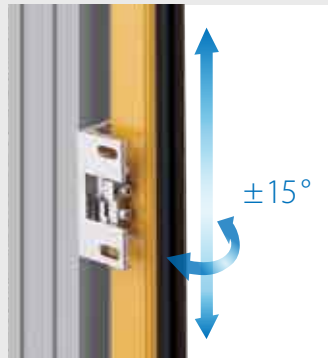

- Vertical adjustment
Angle adjustment range : $\pm 15^\circ$
- Side mounting and backside mounting
- Two brackets per set

For F3SG-PG Perimeter
Guarding Deflect Mirror

F39-LSGA-C Available early 2020

Adjustable Top/
Bottom Bracket

F3SJ, F3SN Adapter
F39-LSGTB-SJ



- Used at the top and bottom of the light curtain
- Angle adjustment range : $\pm 22.5^\circ$
- For replacement of F3SJ or F3SN Series
- Side mounting and backside mounting
- Two brackets per set

For F3SG-PG Perimeter
Guarding Deflect Mirror

F39-LSGTB-C Available early 2020

Mounting brackets to easily replace your existing Omron light curtains are also available.

For replacement of
F3SG-RA/RE Series

Adjustable Top/Bottom Bracket
F3SG-RA/RE Adapter
F39-LSGTB-RE



For replacement of MS4800 Series
and F3SR-B Series

Adjustable Top/Bottom Bracket
MS4800/F3SR Adapter
F39-LSGTB-MS



Product Selection

Step 3: Choose a wiring method

One light curtain

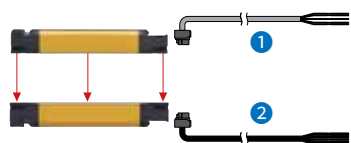

• Cable extension (up to 100 m)

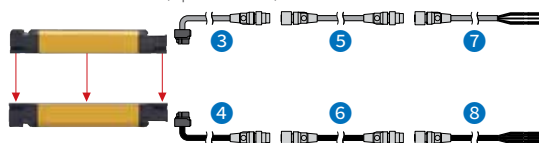

Series-connected

• Side-by-side cascading (12 cm)

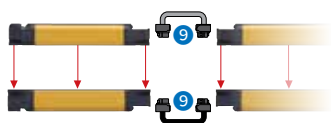

• Cascading cable extension (up to 10 m)

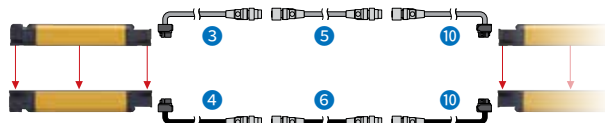

Use of reduced wiring connector

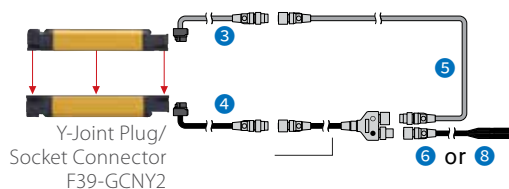

Use of Intelligent Tap

• Always connected

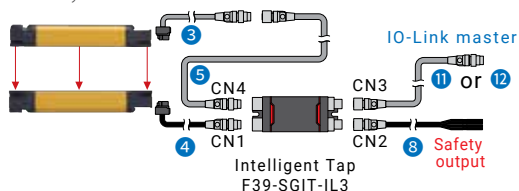

Replacement of Omron light curtain

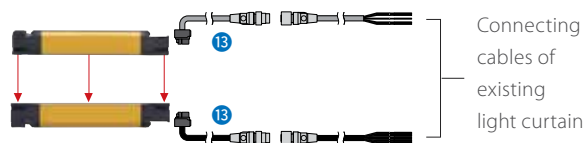

• Connected for setting (optical synchronization)

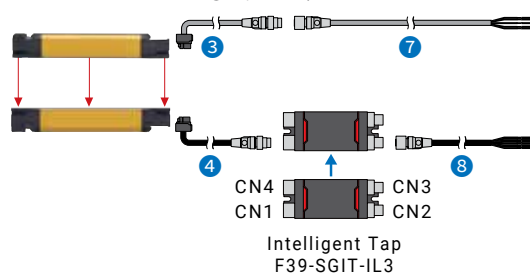

No.	Product name	Appearance	Model	Cable length	Remarks
1	Endcap-Straight Cable		F39-JG□C-L	3, 7, 10 m	For emitter, gray
2	Endcap-Straight Cable		F39-JG□C-D	3, 7, 10 m	For receiver, black
3	Endcap-Plug Cable for Extended		F39-JGR3K-L	30 cm	For emitter, gray
4	Endcap-Plug Cable for Extended		F39-JGR3K-D	30 cm	For receiver, black
5	Extended Plug-Socket Cable		F39-JG□B-L	3, 10, 20 m	For emitter, gray
6	Extended Plug-Socket Cable		F39-JG□B-D	3, 10, 20 m	For receiver, black
7	Extended Socket-Straight Cable		F39-JG□A-L	3, 10 m	For emitter, gray
8	Extended Socket-Straight Cable		F39-JG□A-D	3, 10 m	For receiver, black
9	Side-by-side Cascading Cable		F39-JGR12L	12 cm	For emitter and receiver, two cables per set
10	Cascading Cable for Extended		F39-JGR3W	30 cm	For emitter and receiver, two cables per set
11	Socket-Straight Cable for IO-Link		F39-JG□B-L	3, 10, 20 m	For connection to GX-ILM08C
12	Root-Straight Cable for IO-Link		XS5F-D521-DJ0-IL	2 m	For connection to NX-ILM400
13	Conversion Cable		F39-JGR3K-SJ	30 cm	For use of wiring for F3SN, F3SJ-A/-B, or F3SR
			F39-JGR3K-RE	30 cm	For use of wiring for F3SG-RE
			F39-JGR3K-MS	30 cm	For use of wiring for MS4800

Product Selection

Step 4: Choose the accessories you need

Intelligent Tap and configuration tool SD Manager 3

Easy monitoring, setting, and IO-Link connection with external devices

Intelligent Tap

F39-SGIT-IL3



Configuration tool for PC

SD Manager 3



Bluetooth Communication Unit

F39-SGBT



Monitoring tool for smartphones and tablets

SD Manager 3 Mobile APP

Requirements
Android 7.0 or higher/Windows 10
For details, refer to your local Omron website.



Reduced wiring system

Simple wiring of light curtains and reset switches

Y-Joint Plug/Socket Connector

F39-GCNY2



Reset Switch Connector

F39-GCNY3

Note : Please prepare a reset switch (NC contact).



Muting system

Easy installation and wiring of muting sensors

Muting Sensor Mounting Arm Bracket

F39-FMA□□□T

(Through-beam)

Available early 2020

F39-FMA□□□R

(Retro-reflective)

Available early 2020



Muting Sensor Connection Box

F39-GCN5

Available early 2020

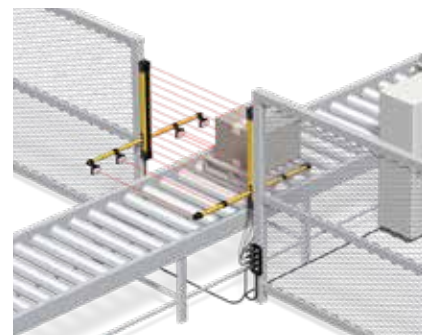

Floor mount system

Easy installation of light curtains and mirrors on floors

Floor Mount Column

F39-ST Available early 2020

Mount-Column Adjustable Base

F39-STB Available early 2020

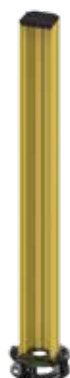
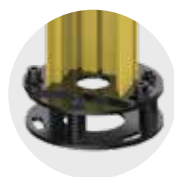

Mirror Column (for F3SG-SR Safety Light Curtain)

F39-SML Available early 2020

Mirror Column (for F3SG-PG Safety Multi-Light Beam)

F39-PML Available early 2020

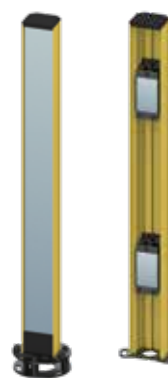

Laser Alignment Pointer

Easy beam adjustment with laser beam

F39-PTG



Lamp

At-a-glance check of light curtain status

F39-SGLP Available early 2020

Note: The Lamp does not support Bluetooth communication.



Spatter Protection Cover

Protection of optical surfaces
against spatter

F39-HSG



- STI is a trademark or registered trademark of OMRON Corporation in Japan and other countries.
- The Bluetooth® word mark and logo are registered trademarks and are owned by the Bluetooth SIG, Inc. and any use of such mark by OMRON Corporation is under license.
- Microsoft product screen shot(s) reprinted with permission from Microsoft Corporation.
- Some images are used under license from Shutterstock.com.
- USB Type-C™ is a trademark of USB Implementers Forum.
- Windows® is a registered trademark of Microsoft Corporation in the USA and other countries.
- The official name of Windows 10 is Microsoft® Windows® 10 Operating System.
- Android™ is a trademark of Google LLC.
- The product photographs and figures that are used in this catalog may vary somewhat from the actual products.
- Other company names and product names in this document are the trademarks or registered trademarks of their respective companies.

OMRON AUTOMATION AMERICAS HEADQUARTERS • Chicago, IL USA • 847.843.7900 • 800.556.6766 • automation.omron.com

OMRON CANADA, INC. • HEAD OFFICE

Toronto, ON, Canada • 416.286.6465 • 866.986.6766 • automation.omron.com

OMRON ELECTRONICS DE MEXICO • HEAD OFFICE

Ciudad de México • 52.55.5901.4300 • 01.800.386.6766 • mela@omron.com

OMRON ELECTRONICS DE MEXICO • SALES OFFICE

San Pedro Garza García, N.L. • 81.12.53.7392 • 01.800.386.6766 • mela@omron.com

OMRON ELECTRONICS DE MEXICO • SALES OFFICE

Eugenio Garza Sada, León, Gto • 01.800.386.6766 • mela@omron.com

OMRON ELETRÔNICA DO BRASIL LTDA • HEAD OFFICE

São Paulo, SP, Brasil • 55.11.2101.6300 • www.omron.com.br

OMRON ARGENTINA • SALES OFFICE

Buenos Aires, Argentina • +54.11.4521.8630 • +54.11.4523.8483
mela@omron.com

OTHER OMRON LATIN AMERICA SALES

+54.11.4521.8630 • +54.11.4523.8483 • mela@omron.com

Authorized Distributor:

Controllers & I/O

- Machine Automation Controllers (MAC) • Motion Controllers
- Programmable Logic Controllers (PLC) • Temperature Controllers • Remote I/O

Robotics

- Industrial Robots • Mobile Robots

Operator Interfaces

- Human Machine Interface (HMI)

Motion & Drives

- Machine Automation Controllers (MAC) • Motion Controllers • Servo Systems
- Frequency Inverters

Vision, Measurement & Identification

- Vision Sensors & Systems • Measurement Sensors • Auto Identification Systems

Sensing

- Photoelectric Sensors • Fiber-Optic Sensors • Proximity Sensors
- Rotary Encoders • Ultrasonic Sensors

Safety

- Safety Light Curtains • Safety Laser Scanners • Programmable Safety Systems
- Safety Mats and Edges • Safety Door Switches • Emergency Stop Devices
- Safety Switches & Operator Controls • Safety Monitoring/Force-guided Relays

Control Components

- Power Supplies • Timers • Counters • Programmable Relays
- Digital Panel Meters • Monitoring Products

Switches & Relays

- Limit Switches • Pushbutton Switches • Electromechanical Relays
- Solid State Relays

Software

- Programming & Configuration • Runtime